



# SLIMLINE LED EXIT SIGN LX Series

## Specification

|                          |   |
|--------------------------|---|
| Mode of operation        | Maintained  |
| Input voltage            | 85 - 245 Vac / 50 Hz  |
| Lamps                    | Mid-power / high-lumen LEDs - brightness complying with EIT 2004-54   |
| Color temperature        | 6500 K  |
| Signage                  | Light-diffusing Shinkolite acrylic sandwiched between two white Shinkolite acrylic sheets   |
| Battery                  | Nickel metal hydride (NiMH) 3 x 1.2 V 2100 mAh  |
| Backup time              | 3 hrs   |
| Battery charging method  | Automatic solid-state system with constant voltage and current limit  |
| Battery cut-off voltage  | 1.0 V / cell  |
| Maximum charging current | 230 mA  |
| Charging time            | 10 - 15 hrs   |
| Manual test              | For LX-N series: performed by pushing Test button<br>For LX-R series: either pushing Test button or using remote control  |
| Remote*                  | Remote control for manual test (for LX-R series only)   |
| Standards                | TIS 1955-2551, ISO 9001   |
| Casing                   | For ceiling-mounted, wall-mounted, and ceiling-hung types:<br>1.1-mm-thick extruded aluminum coated with powder paint<br>For ceiling recessed type: 0.8-mm-thick steel sheet coated with powder paint |

\*Remote control not included in the package  
\*รีโมทคอนโทรลเป็นอุปกรณ์เสริมซึ่งจะจำหน่ายแยกกับผลิตภัณฑ์

## LX-N SERIES

| Model      | Symbol height | Lamp rated power | Installation     | Signage      | Remote support | Dimmable |
|------------|---------------|------------------|------------------|--------------|----------------|----------|
| LX-S10N-1A | 10 cm         | 10 LEDs x 0.6 W  | Ceiling mounted  | Single sided | No             | No       |
| LX-S10N-2A | 10 cm         | 10 LEDs x 0.6 W  | Ceiling mounted  | Double sided | No             | No       |
| LX-S10N-1B | 10 cm         | 10 LEDs x 0.6 W  | Wall mounted     | Single sided | No             | No       |
| LX-S10N-1C | 10 cm         | 10 LEDs x 0.6 W  | Ceiling hung     | Single sided | No             | No       |
| LX-S10N-2C | 10 cm         | 10 LEDs x 0.6 W  | Ceiling hung     | Double sided | No             | No       |
| LX-S10N-1D | 10 cm         | 10 LEDs x 0.6 W  | Ceiling recessed | Single sided | No             | No       |
| LX-S10N-2D | 10 cm         | 10 LEDs x 0.6 W  | Ceiling recessed | Double sided | No             | No       |
| LX-S15N-1A | 15 cm         | 14 LEDs x 0.6 W  | Ceiling mounted  | Single sided | No             | No       |
| LX-S15N-2A | 15 cm         | 14 LEDs x 0.6 W  | Ceiling mounted  | Double sided | No             | No       |
| LX-S15N-1B | 15 cm         | 14 LEDs x 0.6 W  | Wall mounted     | Single sided | No             | No       |
| LX-S15N-1D | 15 cm         | 14 LEDs x 0.6 W  | Ceiling recessed | Single sided | No             | No       |
| LX-S15N-2D | 15 cm         | 14 LEDs x 0.6 W  | Ceiling recessed | Double sided | No             | No       |

## LX-R SERIES

| Model      | Symbol height | Lamp rated power | Installation     | Signage      | Remote support | Dimmable |
|------------|---------------|------------------|------------------|--------------|----------------|----------|
| LX-S10R-1A | 10 cm         | 10 LEDs x 0.6 W  | Ceiling mounted  | Single sided | Yes            | Yes      |
| LX-S10R-2A | 10 cm         | 10 LEDs x 0.6 W  | Ceiling mounted  | Double sided | Yes            | Yes      |
| LX-S10R-1B | 10 cm         | 10 LEDs x 0.6 W  | Wall mounted     | Single sided | Yes            | Yes      |
| LX-S10R-1C | 10 cm         | 10 LEDs x 0.6 W  | Ceiling hung     | Single sided | Yes            | Yes      |
| LX-S10R-2C | 10 cm         | 10 LEDs x 0.6 W  | Ceiling hung     | Double sided | Yes            | Yes      |
| LX-S10R-1D | 10 cm         | 10 LEDs x 0.6 W  | Ceiling recessed | Single sided | Yes            | Yes      |
| LX-S10R-2D | 10 cm         | 10 LEDs x 0.6 W  | Ceiling recessed | Double sided | Yes            | Yes      |
| LX-S15R-1A | 15 cm         | 14 LEDs x 0.6 W  | Ceiling mounted  | Single sided | Yes            | Yes      |
| LX-S15R-2A | 15 cm         | 14 LEDs x 0.6 W  | Ceiling mounted  | Double sided | Yes            | Yes      |
| LX-S15R-1B | 15 cm         | 14 LEDs x 0.6 W  | Wall mounted     | Single sided | Yes            | Yes      |
| LX-S15R-1D | 15 cm         | 14 LEDs x 0.6 W  | Ceiling recessed | Single sided | Yes            | Yes      |
| LX-S15R-2D | 15 cm         | 14 LEDs x 0.6 W  | Ceiling recessed | Double sided | Yes            | Yes      |

# DIMENSIONS

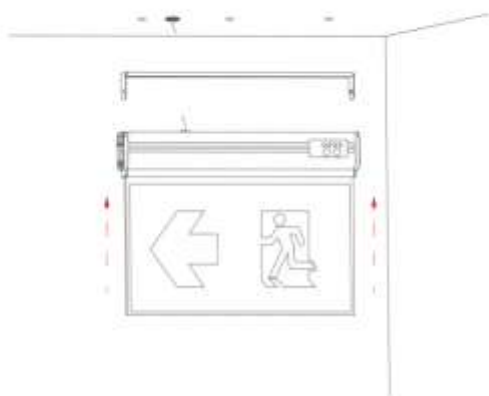
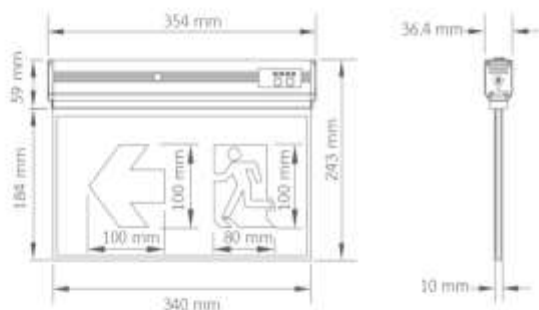

LX-S10N-1A / LX-S10N-2A /  
LX-S10R-1A / LX-S10R-2A

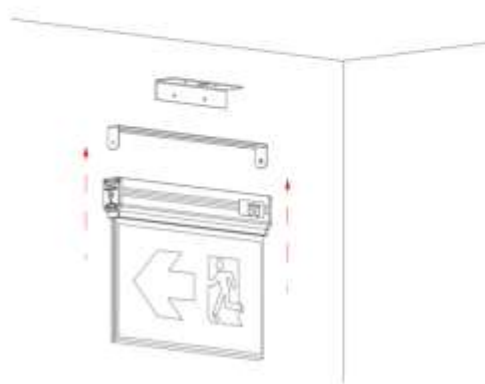
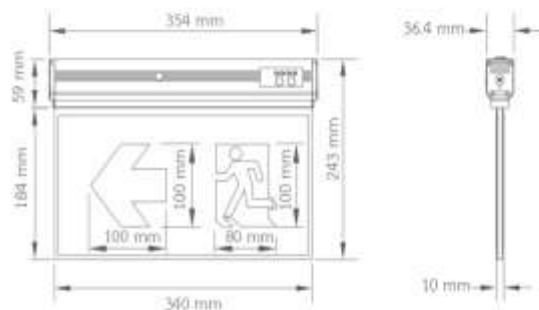

LX-S10N-1B / LX-S10R-1B

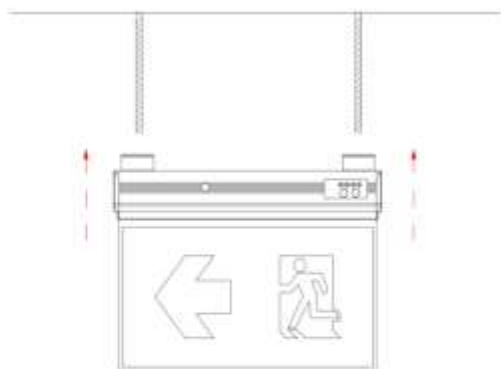
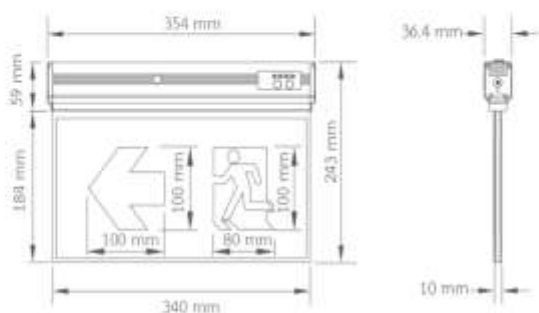

LX-S10N-1C / LX-S10N-2C /  
LX-S10R-1C / LX-S10R-2C /

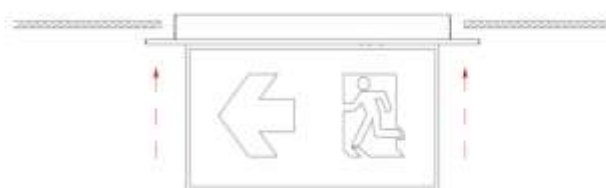
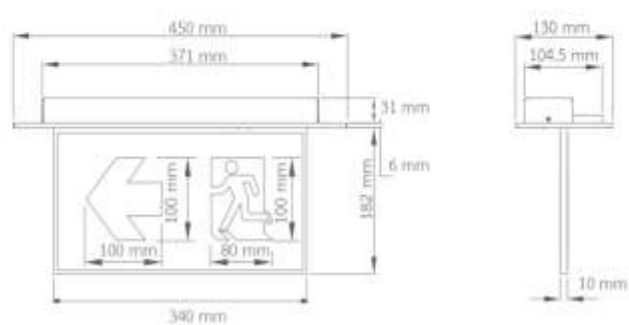

LX-S10N-1D / LX-S10N-2D /  
LX-S10R-1D / LX-S10R-2D

## DIMENSIONS (CONT.)

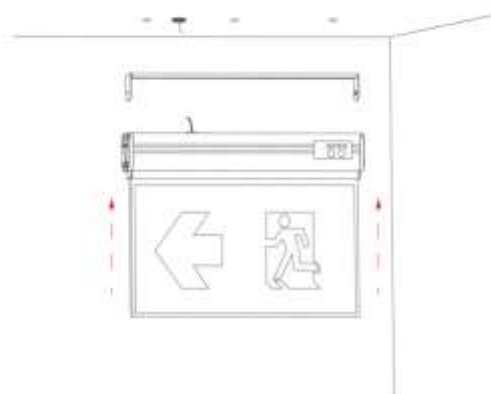
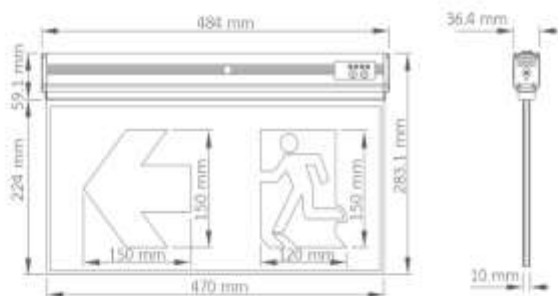

LX-S15N-1A / LX-S15N-2A /  
LX-S15R-1A / LX-S15R-2A

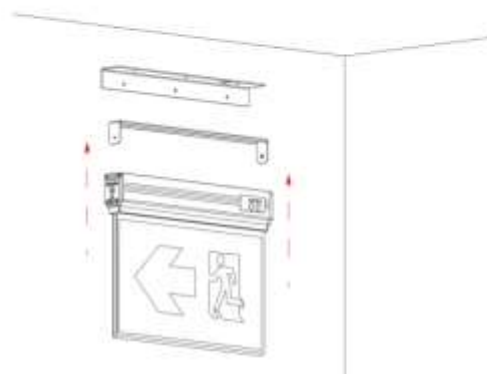
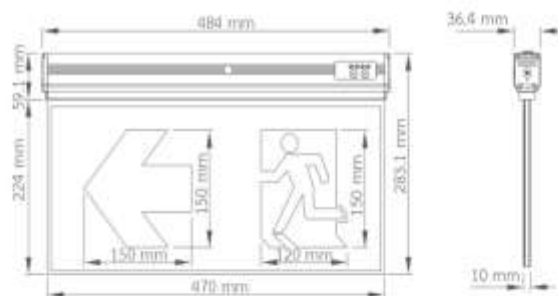

LX-S15N-1B / LX-S15R-1B

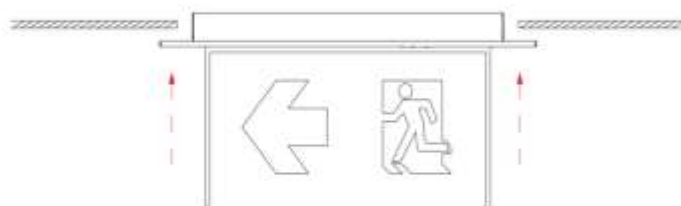
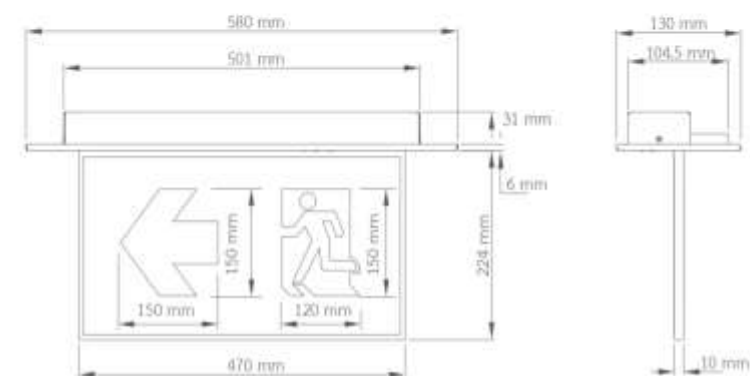

LX-S15N-1D / LX-S15N-2D /  
LX-S15R-1D / LX-S15R-2D

EXIT SIGN PATTERNS COMPLYING WITH EIT 2004-54

รูปแบบป้ายไฟทางออกฉุกเฉินตามมาตรฐาน วสท. 2004-54



E031-01



E041-01



E021-01



E011-01

รูปแบบป้ายไฟทางออกฉุกเฉินทั่วไป



E200-01



E300-01



F310-01



E301-01



F300-01



E330-01



F320-01



E331-01



E301-05



E340-01



F331-03



E341-01



F031-01



E350-01



F341-03



E320-01



F041-01



F321-03



F301-03



E320-04



F011-01



E301-10



F031-02



F100-01



F021-01



F200-01



F041-02



E100-02